

TORRA 203-217

ASSEMBLY INSTRUCTIONS

INSTRUCTION D' ASSEMBLAGE

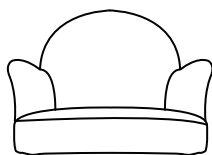
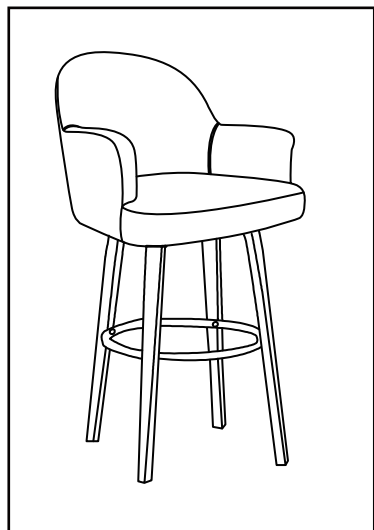

A



Bx4



C

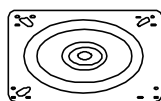



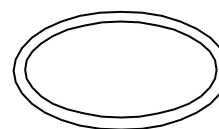



D



E

TURN TOP UPSIDE DOWN ON A SOFT WORKING SURFACE.

RETOURNEZ LE MEUBLE DANS L' AUTRE SENS SUR UNE SURFACE DE TRAVAIL NON RIGIDE.

<p>a</p> <p>M6*30MM</p>  <p>4+1pcs</p>	<p>b</p> <p>M6*20MM</p>  <p>8+1pcs</p>	<p>c</p> <p>M6*16MM</p>  <p>2+1pcs</p>	<p>d</p> <p>M6*25MM</p>  <p>2+1pcs</p>	<p>e</p>  <p>φ 25*10MM</p> <p>2pcs</p>
<p>g</p>  <p>M6</p>				

STEP 1/ETAPE 1

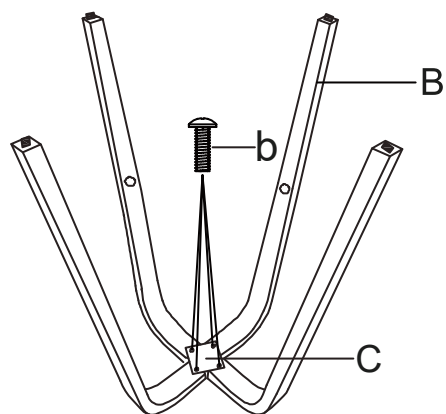
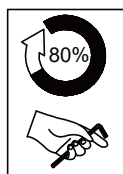

STEP 2/ETAPE 2

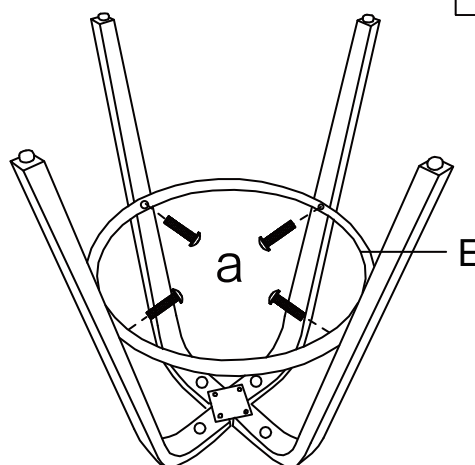
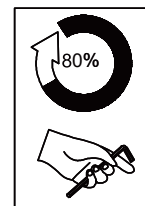

STEP 3/ETAPE 3

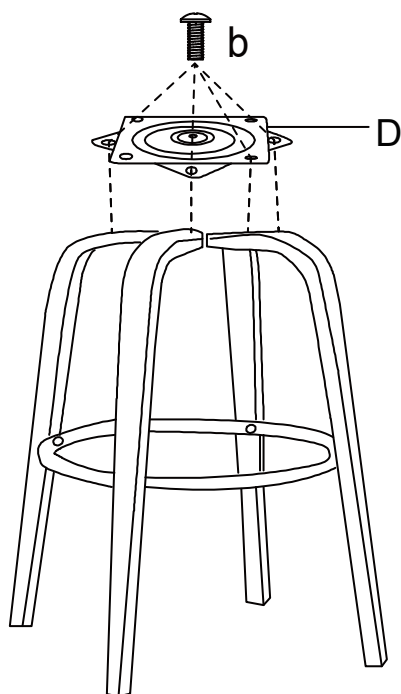
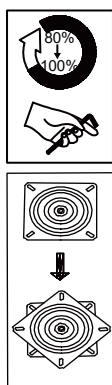

STEP 4/ETAPE 4

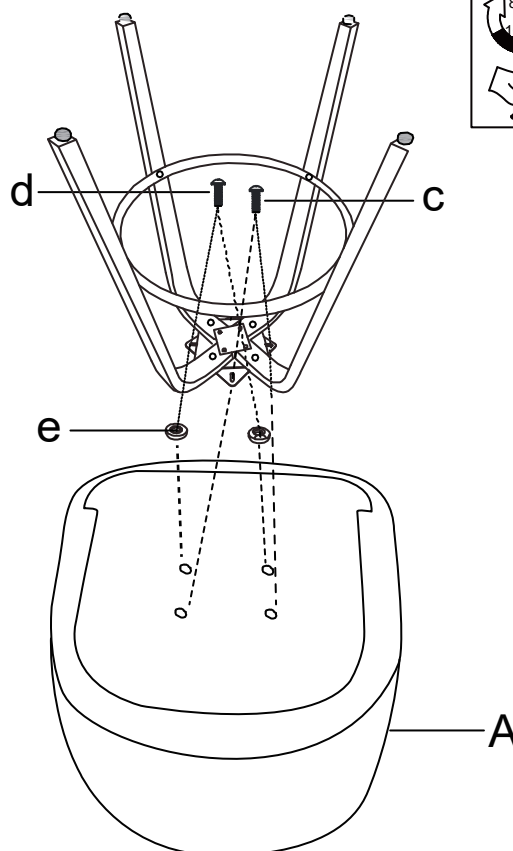
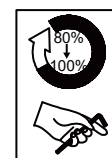

Fasten All screws indicate on Step 1 & Step 2
Serrez toutes les vis indiquées aux étapes 1 et 2

STEP 5/ETAPE 5

