

AVNI 301-619

Assembly Instruction/Instruction D'assemblage

Hardware List / Liste de Materiel



H2 X 12



H3 X 1

Parts List / Liste des Pieces



A (TOP)

A

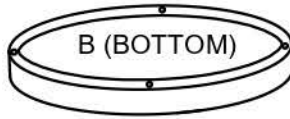

B (BOTTOM)

B

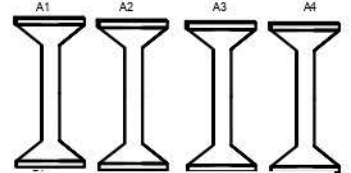

A1

A2

A3

A4

C

Step.1 / Etape. 1

A (TOP)

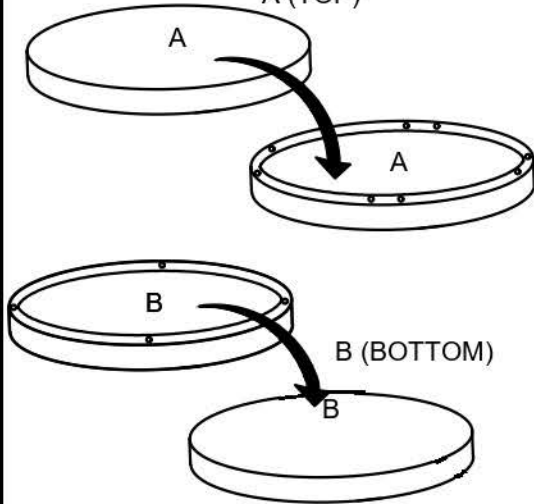

Step.2 / Etape. 2

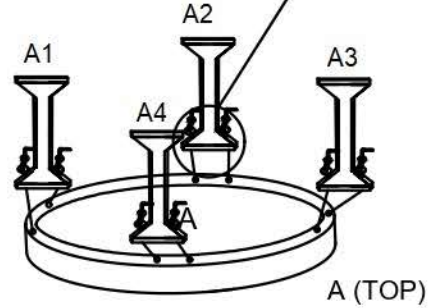
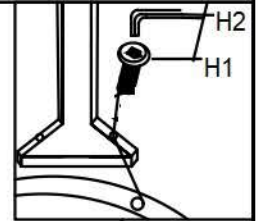

Step.3 / Etape. 3

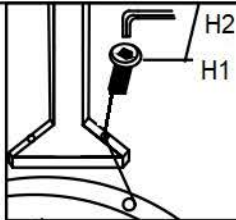

B (BOTTOM)

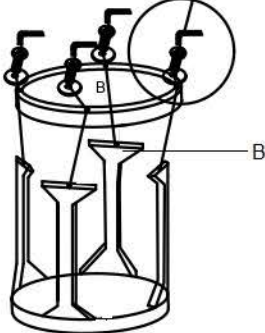

Step.4 / Etape. 4

